

# QUICK SHIP SPEC SHEET

## FARETTO SMALL

LED



SPECIFICATION SHEET

PAGE: 1 OF 2

Project name: \_\_\_\_\_

Type: \_\_\_\_\_



### General information

#### Luminaire characteristics:

**Power input:** 16.7W

**Lumens:** 1331 lm (delivered)

**Luminaire efficacy:** 79 lm/W

**Source:** LED module, 3000K: 80CRI

**Lumen maintenance:** >70% of initial lumens at 50.000 hours (L70)  
LM-80 (LED) / LM-79 tested

**Configuration:** 330° vertical (pan), and 270° horizontal (tilt)  
pivoting axes with locking screws.

**Optics:** Metalized PC reflector 41° beam with clear protection  
glass lens.

**Body:** Extruded aluminum housing and heatsink.

**Electrical:** Integral high efficiency dimmable driver, 120V.

**Dimming:** Power supply compatible with Leading (TRIAC) and  
trailing edge (ELV).

**Mounting:** Track adaptor for 8000 series one circuit track  
(120V).

#### Finish:

51: Natural matte anodized with black accent and black track  
adaptor.

52: Black matte anodized with black accent and black track  
adaptor.

**Weight:** 2lbs. (0.9Kg) including track adaptor.

**Warranty:** 5 years limited warranty.

**Certification:** cULus listed.

**Ratings:** Damp location.

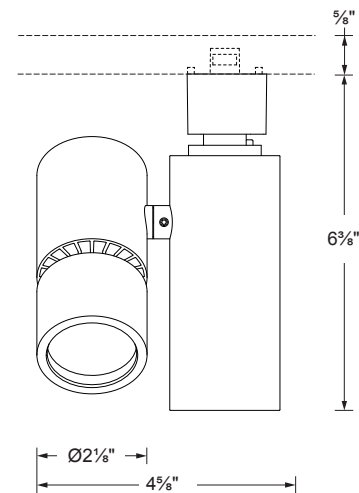

FRONT VIEW

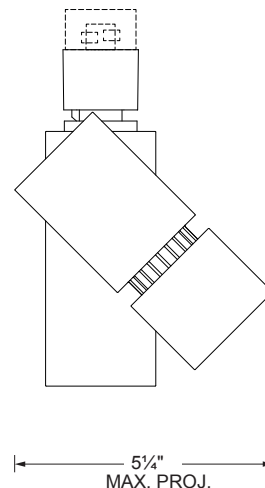

SIDE VIEW

DUE TO CONTINUOUS IMPROVEMENTS, THE INFORMATION HEREIN MAY BE CHANGED WITHOUT NOTICE.

LAST UPDATE: JUNE 15, 2015

MGD - R0

# SISTEMALUX



9320 Boul. St-Laurent,  
suite 100, Montréal (Québec)  
Canada H2N 1N7

P.: 514.523.1339 F.: 514.525.6107  
www.sistemalux.com

# QUICK SHIP SPEC SHEET

## FARETTO SMALL

LED



Project name: \_\_\_\_\_

Type: \_\_\_\_\_





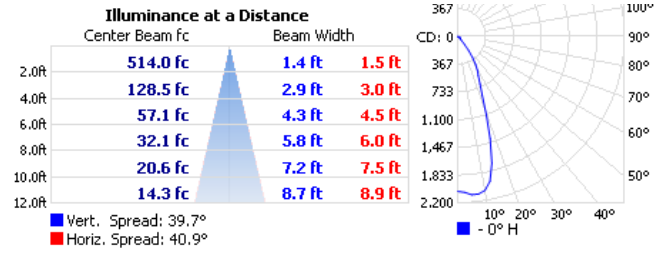

### TECHNICAL DATA

<b>Model:</b>	<b>1590S-830-45-120-XX</b>
<b>Color temp.:</b>	3000K, 80CRI
<b>Optic:</b>	Flood beam, 41°
<b>Power input:</b>	16.7W
<b>Lumens:</b>	1331 lm (delivered)
<b>Luminaire efficacy:</b>	79 lm/W



### ACCESSORIES (TO BE ORDERED SEPARATELY)

\* fixture can hold a maximum of 3 accessories at a time

- 1599** - Frosted lens 
- 1598** - Elliptic lens 
- 1593** - Soft focus lens 
- 1596-52** - Black hex cell louver 
- 1594-52** - Black cross baffle  
Length: 1-5/8" (40mm) 
- 1597-52** - Black snoot  
Length: 1-5/8" (40mm) 
- 1595-52** - Black visor wall washer  
Length: 1-5/8" (40mm) 

### ORDERING INFO

MODEL	LED	OPTIC	VOLTAGE	FINISH
<input type="radio"/> <b>1590S</b> - 8000	<input type="radio"/> <b>830</b> - 3000K, 80CRI	<input type="radio"/> <b>45</b> - 41°	<input type="radio"/> <b>120</b> - 120V	<input type="radio"/> <b>51</b> - Natural matte anodized <input type="radio"/> <b>52</b> - Black matte anodized

DUE TO CONTINUOUS IMPROVEMENTS, THE INFORMATION HEREIN MAY BE CHANGED WITHOUT NOTICE.

LAST UPDATE: JUNE 15, 2015

MGD - R0

# SISTEMALUX



9320 Boul. St-Laurent,  
suite 100, Montréal (Québec)  
Canada H2N 1N7  
P.: 514.523.1339 F.: 514.525.6107  
www.sistemalux.com